



## Design and function

Fittings solutions by Blum

[www.blum.com](http://www.blum.com)

 **blum**<sup>®</sup>



## Contents

### Products

- 6 Lift systems
- 10 Hinge systems
- 14 Box systems
- 28 Runner systems
- 36 Inner dividing systems
- 44 Motion technologies

### Living worlds

- 54 Kitchens
- 60 Living rooms
- 62 Bedrooms
- 64 Bathrooms
- 66 Offices and hallways
- 68 Shops

### DYNAMIC SPACE

- 70 Blum's ideas for practical kitchens
- 72 Workflow
- 74 Space
- 75 Motion

### About Blum

- 76 Quality of motion is quality of life
- 78 Design
- 80 The company

### Services

- 82 Services
- 85 Contact











## There are two sides to everything

### Design

Furniture should be beautiful to look at and meet personal styles - no matter whether it has been designed to suit individual wishes or follow the general trend. Fittings systems by Blum work in the background to make furniture a success. Concealed within interiors they help bring your design ideas and latest trends to life.



**... and function**

Furniture needs to be functional, too, for top functionality is important to furniture users. It's a matter of promoting ergonomic workflows, providing enough storage space and enhancing user convenience.



# Lift systems

**blum**

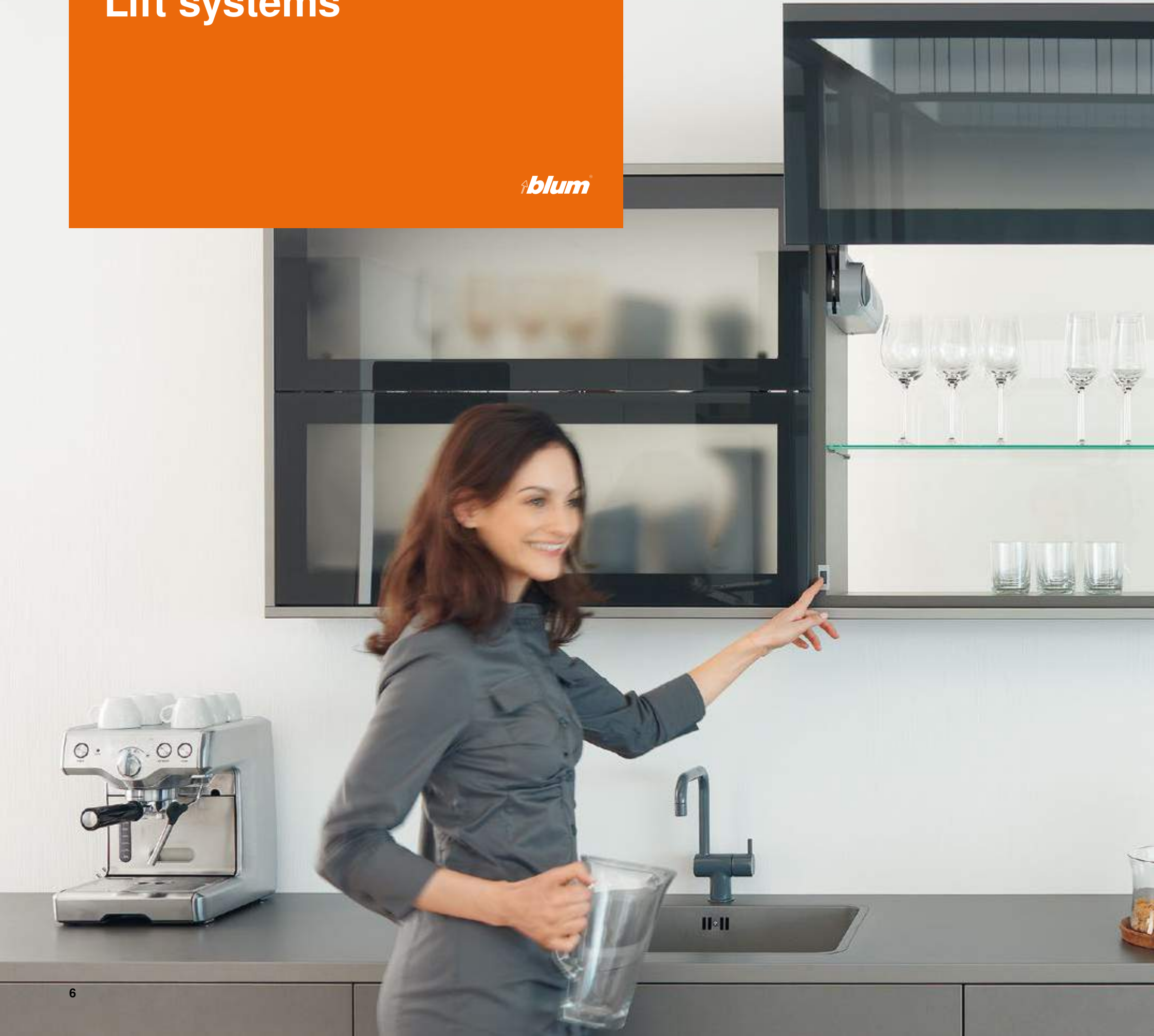





Lift systems bring enhanced ergonomics to wall cabinets. Fronts swing up and out of the user's way providing direct access to cabinet interiors.

AVENTOS lift systems boast supreme user convenience. Even heavy fronts open with ultimate ease and close again softly and effortlessly with integrated soft-close BLUMOTION.

For handle-less designs, simply combine AVENTOS lift systems with the SERVO-DRIVE electric motion support system - and a multitude of design options is yours.



> [www.blum.com/  
liftsystems](http://www.blum.com/liftsystems)



AVENTOS allows you to create vertical and horizontal gap alignments.

## Design

- For widths of up to 1.800 mm and heights of up to 1.040 mm
- Combine several AVENTOS fittings to create extremely wide units
- Large fronts with or without a gap
- You can choose from white, grey or nickel plated AVENTOS cover caps

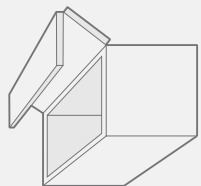

### AVENTOS HF

Bi-fold lift system. The two-part front folds up

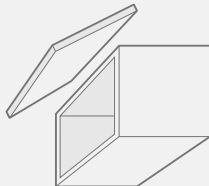

### AVENTOS HS

Up and over lift system. The front swings up and over the cabinet

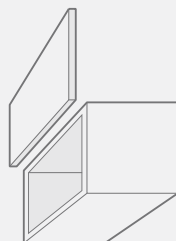

### AVENTOS HL

Lift up. The front lifts up parallel to the cabinet

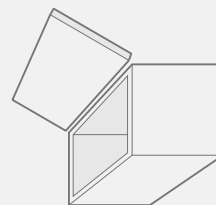

### AVENTOS HK

Stay lift. The front pivots up

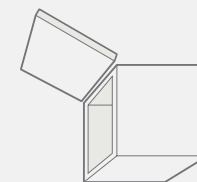

### AVENTOS HK-S

Small stay lift. The front pivots up

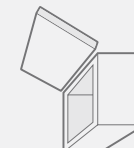

### AVENTOS HK-XS

Very small stay lift. The front pivots up

Available from autumn 2014

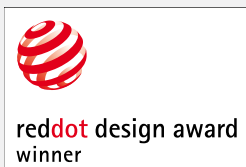





SERVO-DRIVE for AVENTOS. Handle-less fronts open at a single touch ...



... and close again at the press of a switch.

### Function

- Heavy fronts open at a single touch with SERVO-DRIVE
- Fronts stay in the position required
- Soft and effortless closing with BLUMOTION
- Easy access to cabinet contents

# Hinge systems

 blum®

There are CLIP top hinges for many different opening angles and applications, so you can use different door heights, thicknesses and materials as well as glass and mirror doors.

The 3-dimensional hinge adjustment feature makes it easy to produce a uniform and precise gap alignment. Adjustment and fixing screws are nicely concealed by cover caps.

Doors close softly and effortlessly with soft-close BLUMOTION. The technology has been integrated into the CLIP top BLUMOTION hinge so it is concealed from view.







> [www.blum.com/hinges](http://www.blum.com/hinges)



Cover cap designs on hinge arms can be individualised.

### Design

- Special hinges for glass, aluminium frame doors and many other special applications give you freedom of design
- Easy adjustment for beautiful gap alignment
- Hinges for furniture with and without handles
- The hinges blend in harmoniously and inconspicuously with furniture interiors



product  
design award



Designpreis  
Deutschland

NOMINIERT





Enhanced user convenience for cabinets with inner drawers or pull-out surrounds with the CLIP-top 0-protrusion hinge.



The BLUMOTION feature can be deactivated for small or light doors.



Cabinets with mirror doors can be easily implemented with the CLIP-top CRISTALLO hinge.

## Function

- Different opening angles provide easy access to cabinet interiors
- Even heavy doors open and close with ease
- Soft and effortless closing with BLUMOTION

# Box systems

The Blum logo, featuring a stylized upward-pointing arrow above the word "blum" in a lowercase, sans-serif font.

Whether in kitchens, living rooms, bathrooms or offices, drawers are a good idea in every room because they provide clear visibility and easy access to contents.

Box systems offer a wide array of design possibilities so you can easily meet individual wishes. The LEGRABOX programme is characterised by a sleek and straight-cut design. TANDEMBOX offers three different lines to choose from.

Blum's box systems all have a feather-light glide and integrated soft-close BLUMOTION, bringing top quality motion to furniture throughout the home. Handle-less designs can be implemented with the SERVO-DRIVE electric opening support system or the TIP-ON mechanical opening system.



NT, ALWAYS UNIQUE. ALWAYS DIFFERENT. ALWAYS UNIQUE.  
DIFFERENT. ALWAYS UNIQUE. ALWAYS DIFFERENT. ALWAYS  
ALWAYS DIFFERENT. ALWAYS UNIQUE. ALWAYS DIFFERENT.  
UNIQUE. ALWAYS DIFFERENT. ALWAYS UNIQUE. ALWAYS DIF  
ALWAYS UNIQUE. ALWAYS DIFFERENT. ALWAYS UNIQUE. ALW  
ERENT. ALWAYS UNIQUE. ALWAYS DIFFERENT. ALWAYS UNI  
AYS DIFFERENT. ALWAYS UNIQUE. ALWAYS DIFFERENT. ALV

blum

blum

blum



> [www.blum.com/  
boxes](http://www.blum.com/boxes)



## Design

- LEGRABOX and the three TANDEMBOX programme lines offer you a wide array of design options
- Different heights and designs, diverse colours and materials
- Extremely wide drawers and pull-outs
- Handle-less furniture designs
- Easy front adjustment for precise gap alignment and clear cut lines



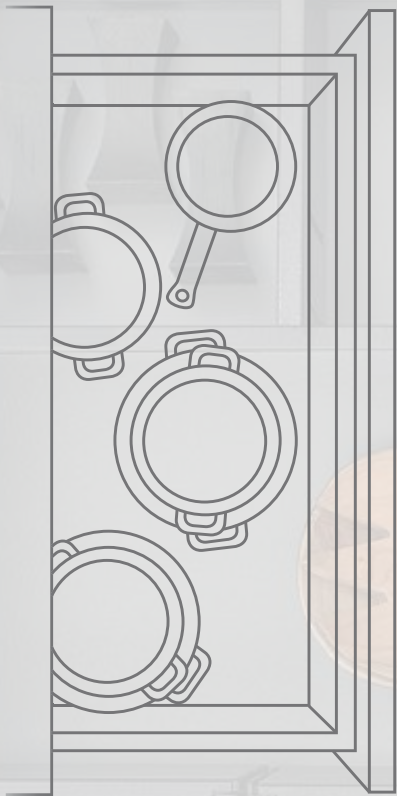

Single extension

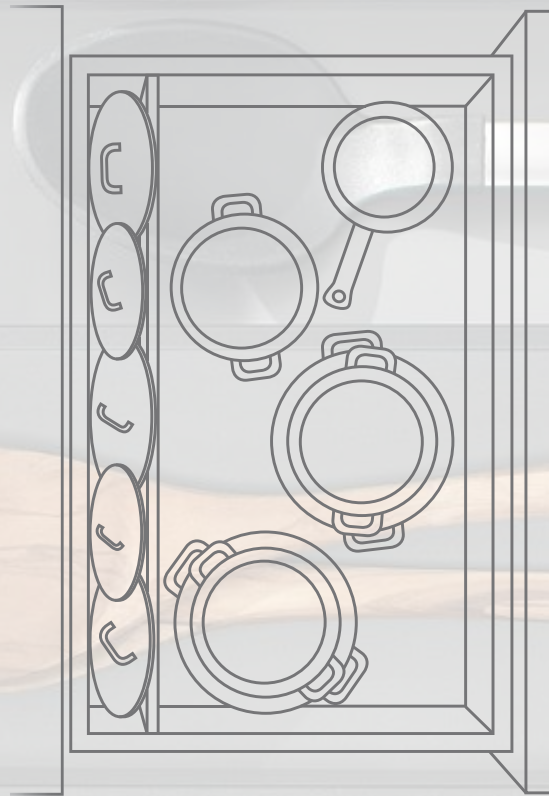

Full extension



Try not to use shelves in base units.

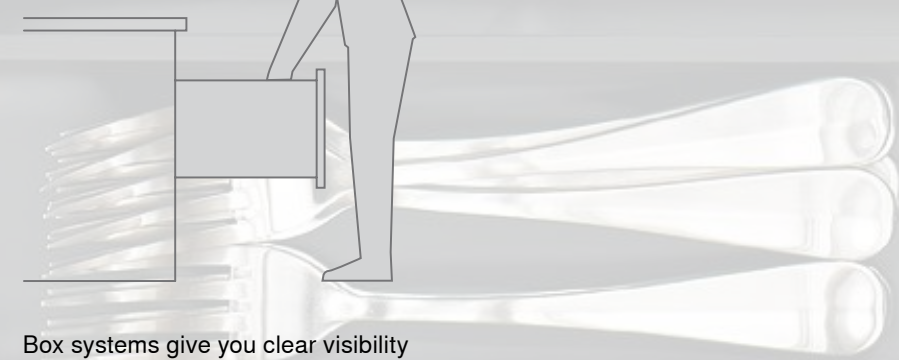

Box systems give you clear visibility and easy access.

### Function

- Box systems for the entire home: High fronted pull-outs, inner pull-outs, drawers, inner drawers or SPACE CORNER cabinets
- Full extensions provide clear visibility and easy access to all contents
- Special inner dividing systems offer a wide range of applications
- Even wide and heavily laden pull-outs open and close with ease
- Opening systems make handle-less furniture easy to open



# LEGRABOX

LEGRABOX gives you a sleek, straight-cut design, top quality motion and supreme user convenience. 3-dimensional height, side and tilt adjustment of fronts produces beautiful gap alignment. Handle-less designs can be easily implemented with a mechanical or electric motion support system.

blum®

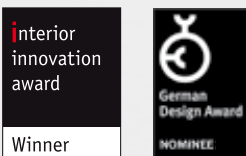
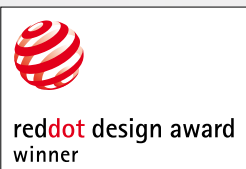



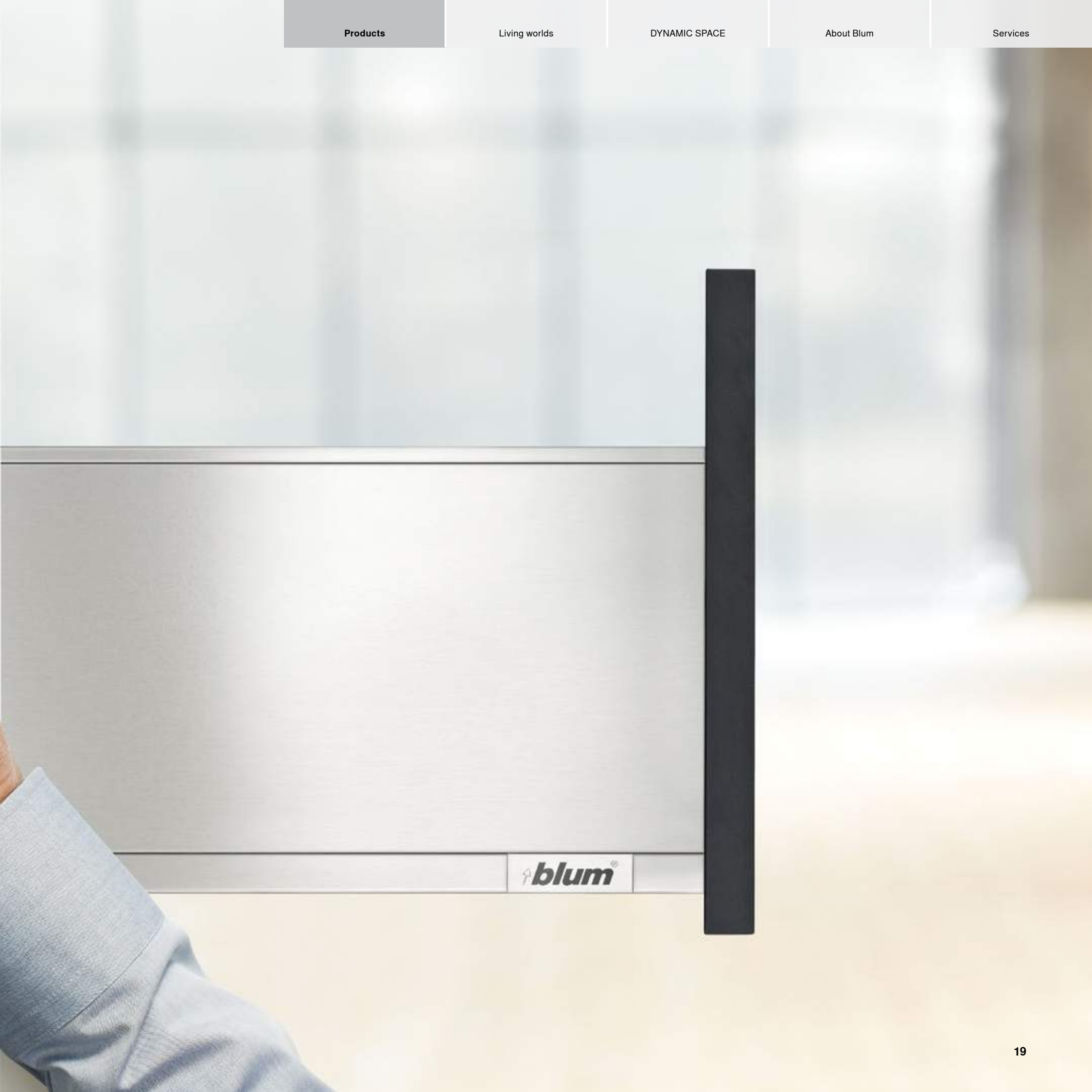

**blum**



**Slim design**

The new design of LEGRABOX supports the latest living trends and opens up new design options throughout the home. The drawer sides are straight (inside and outside) and impressively slim (just 12.8 mm), blending in beautifully with all items of furniture.



> [www.blum.com/  
trailerlegrabox](http://www.blum.com/trailerlegrabox)



Drawers and pull-outs can be implemented in various heights, lengths and colours.



All components are coordinated in terms of colour and material.



LEGRABOX offers a multitude of design options. LEGRABOX free allows you to individualise pull-outs with extensive design elements of your choice. Availability on request.



# TANDEMBOX intivo

TANDEMBOX intivo lets you personalise the design of pull-outs. You can opt for a sleek and classic design with BOXCAP, an add-on in the same material as the drawer side. Or pick a design element of your choice, e.g. leather or glass attached with a BOXCOVER. In other words, TANDEMBOX intivo gives you great freedom of design.

blum

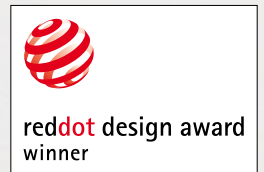



Personalised designs with a choice of design elements attached with a BOXCOVER.



Design elements of imitation leather bring elegance to furniture interiors. There is a wide variety of colours and textures to choose from.



A seamless design with BOXCAP, an add-on in the same material as the drawer side.



Meet your customers' individual requirements with design elements of clear or frosted glass – with or without printing.

## TANDEMBOX antaro

Less is often more! This is where TANDEMBOX antaro comes into play. The components of drawers, inner drawers, high fronted pull-outs and inner pull-outs have all been colour coordinated. You can create a closed container by adding design elements of various materials. The rectangular gallery underlines the minimalist design of cabinets.

 **blum**







TANDEMBOX antaro in silk white.

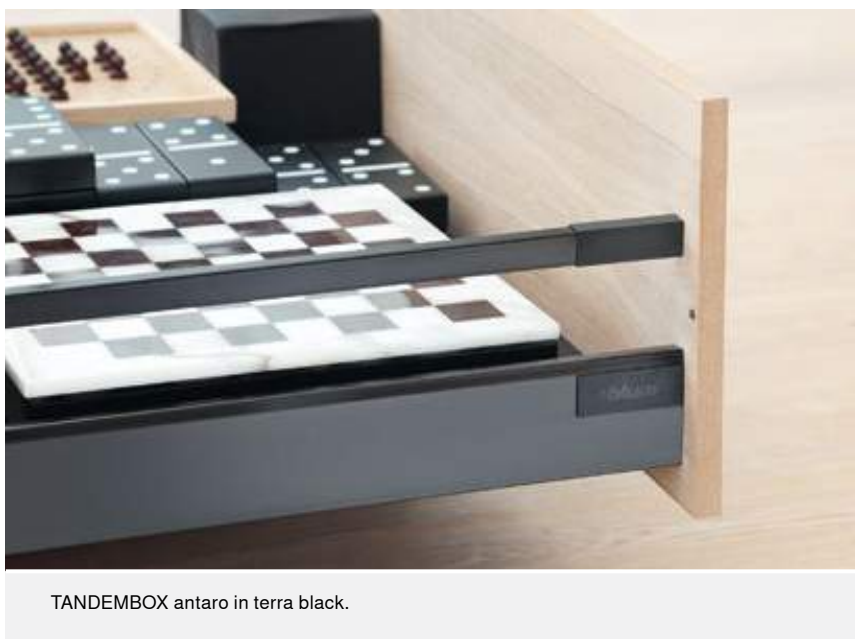

TANDEMBOX antaro in terra black.



TANDEMBOX antaro is also ideal for very narrow cabinets.

## TANDEMBOX plus

TANDEMBOX plus gives you great freedom of design. Drawer sides and backs come in different heights; you can have a round gallery or a closed container. TANDEMBOX plus offers the right solution for a multitude of applications. The programme line is characterised by a round gallery and uniform, grey nylon parts.

 **blum**





You can have a single or double gallery or a closed container with BOXSIDE – TANDEMBOX plus is extremely versatile.

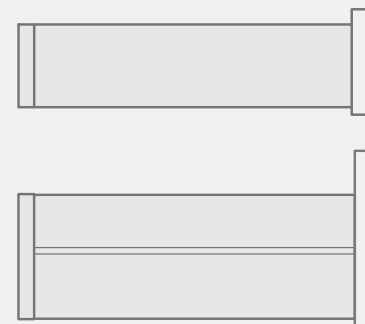
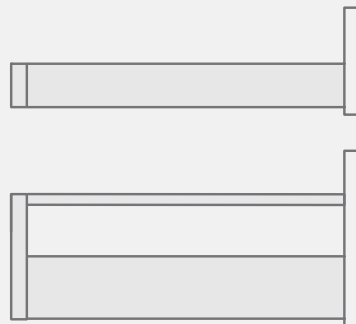



# Runner systems

 blum®



> [www.blum.com/  
runners](http://www.blum.com/runners)



Wooden drawers come in all shapes and sizes, can be made by cabinet-makers or industrial manufacturers – but they all have a feather-light glide with runner systems by Blum (even when heavily laden).

You can use an electric or mechanical opening support system to implement handle-less designs. Drawers close softly and effortlessly with integrated BLUMOTION.





### Design

- Runners are concealed
- Wide range of design possibilities, e.g. pull-out surrounds, small drawers or extremely wide pull-outs
- Precise gap alignment thanks to easy front adjustment
- Handle-less designs are possible



## Function

- Good sag values and feather-light glide even when heavily laden
- Full extensions give you clear visibility and easy access to all contents
- Handle-less fronts open with ease thanks to the opening support system
- Soft and effortless closing with BLUMOTION

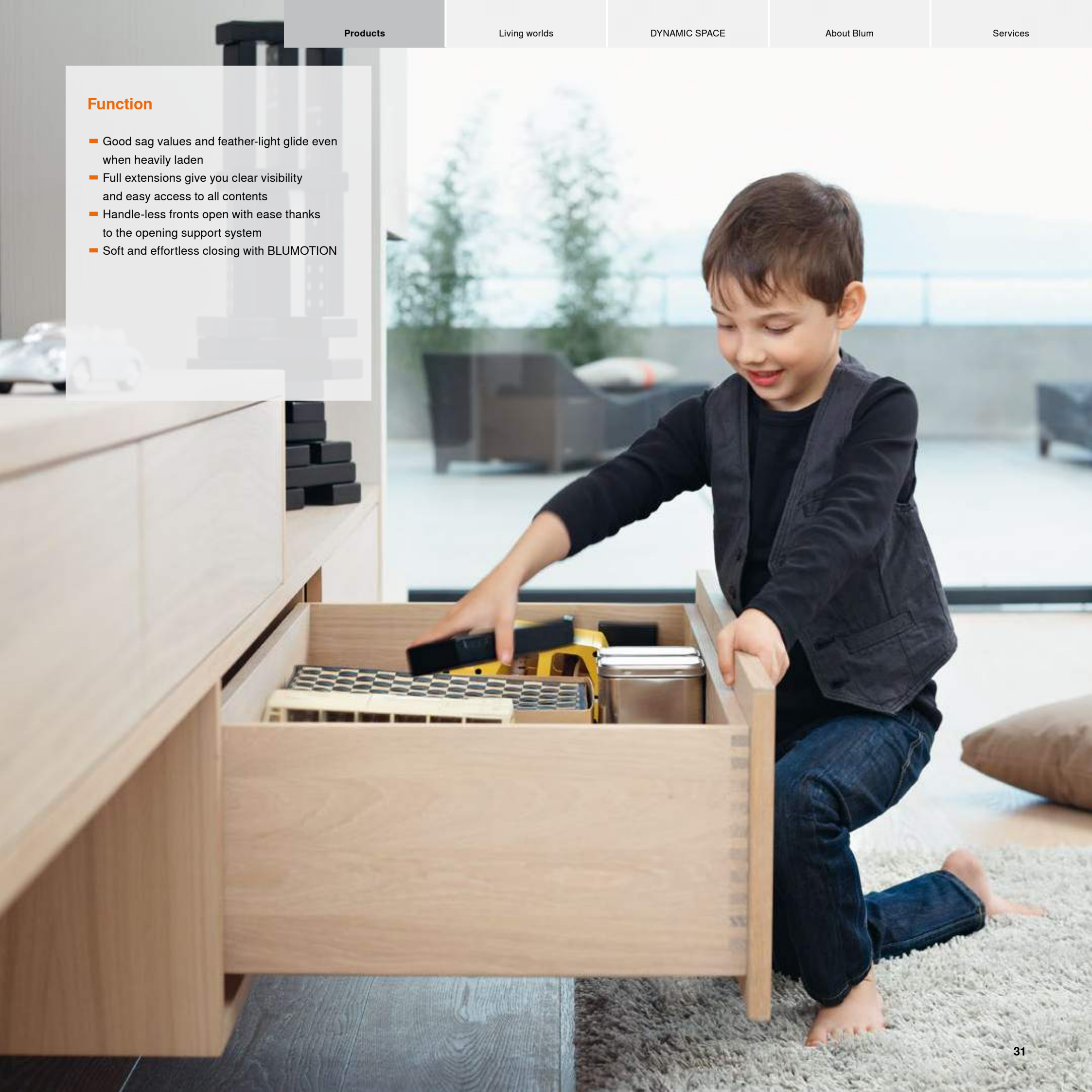



# MOVENTO

The evolution of motion. MOVENTO takes Blum's tried and tested running action to the next level. It offers a synchronised feather-light glide and top quality motion. For all applications, from drawers and inner drawers to high fronted pull-outs and inner pull-outs.

blum®



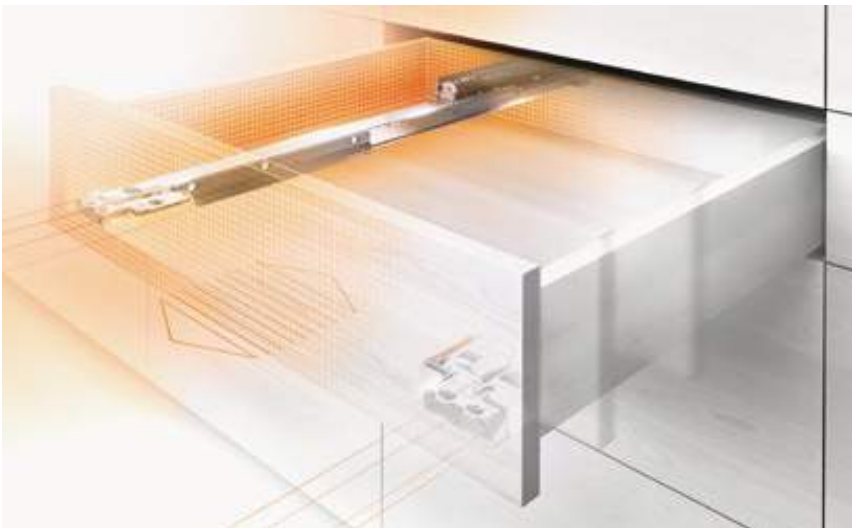

The MOVENTO synchronised runner system offers ultra smooth running action.



4-dimensional height, side, tilt and depth adjustment produce precise gap alignment.



MOVENTO is top in terms of quality, loading capacity and stability.



# TANDEM

TANDEM is Blum's tried and tested runner system for wooden drawers and pull-outs. Even heavily laden full and single extensions have a feather-light glide. The extremely good sag values mean that you can even implement extra wide and large pull-outs close to the floor.

 **blum**



Optional side stabilisation ensures that extremely wide pull-outs have a smooth and stable running action.



The Blum technology behind the feather-light glide: roller carriage with low-friction nylon rollers and a smooth transition between profiles to reduce noise.



# Inner dividing systems

 blum



> [www.blum.com/  
innerdividingsystems](http://www.blum.com/innerdividingsystems)

Blum's practical inner dividing systems organise every drawer and pull-out. AMBIA-LINE for LEGRABOX and ORGA-LINE for TANDEMBOX let you store everything tidily and accessibly. Provisions, cutlery, toiletries, accessories, etc. Storage space is put to optimal use and interiors are tailored to individual needs.









## Design

- Harmonious overall appearance. Inner dividing systems carry the characteristic design of the box system through to interiors
- Trays and frames can be positioned wherever needed; cross and longside dividers can be adjusted to contents
- High quality materials such as steel, stainless steel and wood décors

## Function

- For tidy drawers and pull-outs throughout the home
- Storage space is put to optimal use and interiors are tailored to individual needs
- Simple to handle and easy to clean
- Everything where it should be and immediately to hand
- Practical kitchen accessories such as knife holder, film/foil dispenser, spice holder and plate holder





## AMBIA-LINE for LEGRABOX

The inner dividing system for LEGRABOX is slim and elegant and beautifully organises interiors throughout the home. The flexible frames can be placed wherever needed and harmonise perfectly with the LEGRABOX drawer. They are simple to handle and versatile in application.

 **blum**



➤ AMBIA-LINE  
Imagetrailer



AMBIA-LINE comes in steel or with wood décor.



Choice of materials and colours. Either to match drawer sides or set accents in interiors.



The various frames can be placed wherever needed in drawers.



## ORGA-LINE for TANDEMBOX

The ORGA-LINE inner dividing system for TANDEMBOX works wonders on the interiors of drawers and high fronted pull-outs. Flexible cross and longside dividers as well as full width and modular sets can be adjusted to contents. High quality stainless steel trays provide clear visibility and easy access to all contents.

 blum





Bottles and chopping boards are easily accessible.



ORGA-LINE is a beautiful way to organise interiors.



Flexible cross and longside dividers can be adjusted to contents.



ORGA-LINE for drawers ensures that all kinds of items are kept safe and are easily accessible.



# Motion technologies

**blum**



> [www.blum.com/  
technologies](http://www.blum.com/technologies)



Fitting solutions by Blum should make furniture more practical, more convenient and easier to use. All of Blum's lift, hinge, box and runner systems are designed to meet this objective.

To this end, we have developed innovative motion technologies that not only make furniture more practical - they also offer a wide array of new design options.



## Design

- A multitude of new design possibilities for modern furniture, e.g. handle-less fronts
- Immense scope for the design of pull-outs, wall cabinets and doors
- Soft-close BLUMOTION has already been integrated into all systems and is therefore concealed



## Function

- Pull-outs, wall cabinets and doors open with ease with the mechanical or electric opening support system
- Handle-less fronts open by themselves at a single touch
- Soft and effortless closing with soft-close BLUMOTION

The **SERVO-DRIVE** and **TIP-ON** opening support systems as well as **BLUMOTION** are available for these systems.

	BLUMOTION	SERVO-DRIVE	TIP-ON <sup>1)</sup>
Lift systems	■	■	■ <sup>2)</sup>
Hinge systems	■		■
Box systems	■	■	■
Runner systems	■	■	■

<sup>1)</sup> Cannot be combined with BLUMOTION

<sup>2)</sup> Only available for AVENTOS HK, HK-S and HK-XS



# BLUMOTION

Furniture closes softly and effortlessly with BLUMOTION no matter how heavy the pull-out, front or door and no matter how hard you slam them shut. The soft-close feature is integrated into lift systems, hinges, box and runner systems.

 **blum**



Doors don't bounce open again - no matter how hard you slam them shut.



Heavily laden drawers and pull-outs close softly and stay closed.



Even heavy wall cabinet fronts close softly and effortlessly.



## TIP-ON

Whether it's stay lifts, doors, drawers, or pull-outs: Handle-less furniture can be used throughout the home thanks to the TIP-ON mechanical opening system. Close with a slight push or simply press shut.

 **blum**



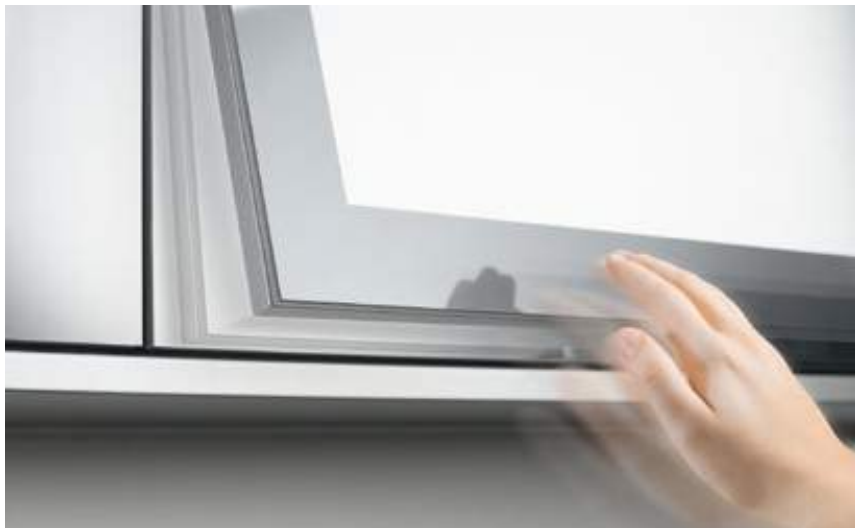

Opening handle-less wall cabinet fronts is easy with TIP-ON.



Handle-less doors open at a single touch.



Reliable opening for drawers and pull-outs with TIP-ON.



# SERVO-DRIVE

Fronts without handles are the latest design trend. It's very easy to implement handle-less furniture with the SERVO-DRIVE electric opening system. Wall cabinets, drawers and pull-outs open automatically at a single touch.

**blum**

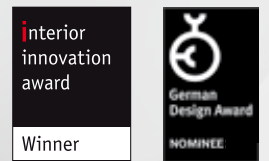



- A single technology, i.e. one system for all applications in wall cabinets and base units
- Easy installation
- Safe operation
- Low power consumption
- Manual operation possible at all times
- Soft-close BLUMOTION
- 5-year warranty



# Living worlds

**blum**



The design and function of furniture differ depending on living area. Our comprehensive programme gives you a multitude of solutions to choose from - for kitchens, bedrooms, living rooms, bathrooms, hallways and shop fit-outs.











## Kitchens

Merging cooking, dining and living space is still a big trend. That's why more and more importance is being attached to the design of kitchens. But kitchens need to be functional, too. This is where Blum comes in with its practical solutions.



Application for bottles and chopping boards.



Plates can be safely stacked and quickly carried to dining-tables with Blum's plate holder.



AMBIA-LINE for cutlery.





ORGA-LINE film dispenser in drawers.



Blum's sink unit makes optimal use of the storage space available.



Pull-out with ORGA-LINE spice holder.

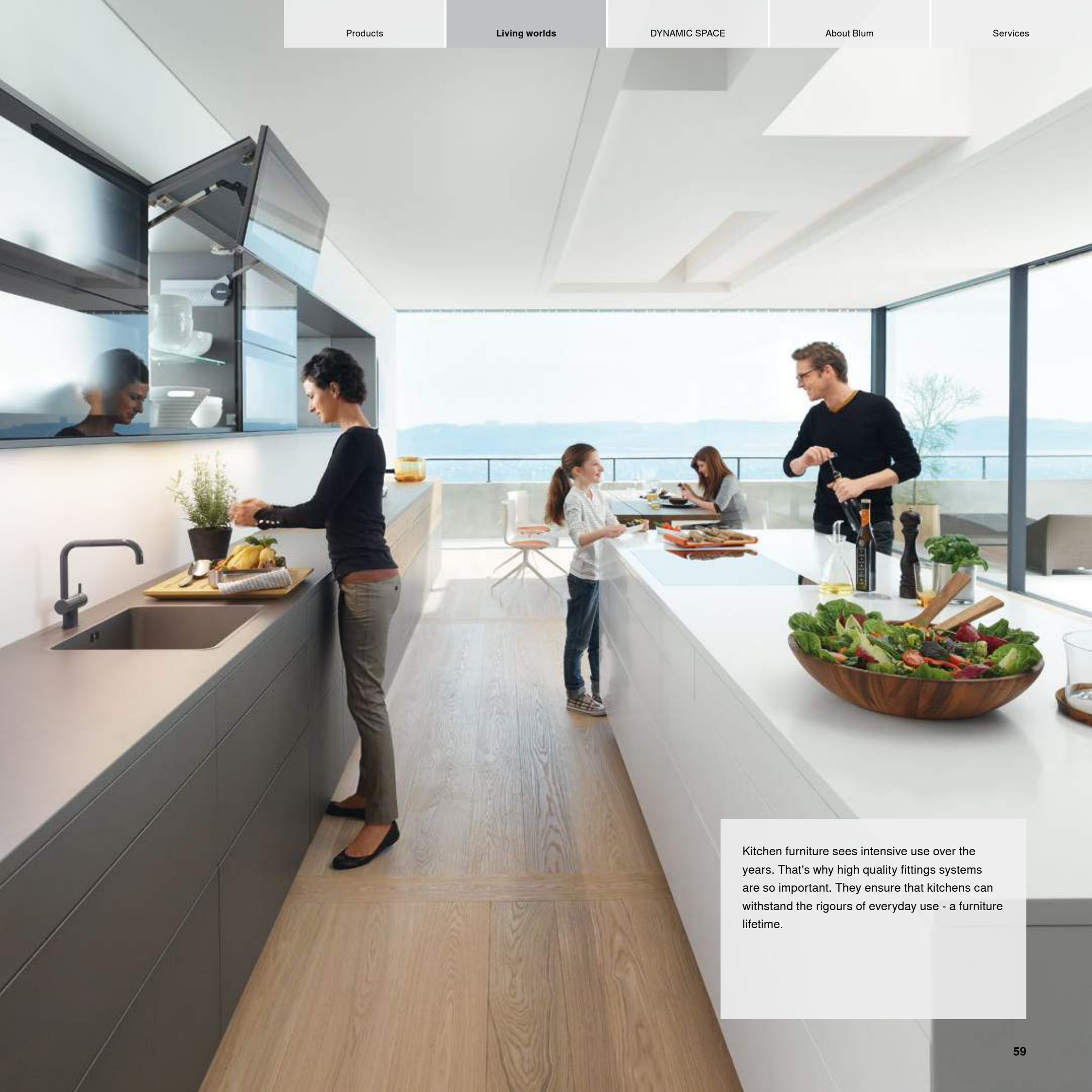

Kitchen furniture sees intensive use over the years. That's why high quality fittings systems are so important. They ensure that kitchens can withstand the rigours of everyday use - a furniture lifetime.





## Living rooms

Living room furniture should also be well-thought-out and practical. Beautiful design is not the only thing that counts. It's important to use every inch of storage space available and provide easy access to contents.



Media solution and AVENTOS HL with SERVO-DRIVE.



## Bedrooms

Soft-close BLUMOTION is ideal for bedrooms. Furniture closes softly and effortlessly and everyone gets a good night's sleep. Enhanced user convenience is rounded off by high stability and smooth running action.











## Bathrooms

Bathroom furniture and fittings have to withstand the impact of humidity. Zinc plated runners and nylon roller carriages offer the best protection against corrosion. In addition, you need furniture solutions that make optimal use of the storage space available. This is where wide drawers with short nominal lengths come in handy. And bathroom furniture closes softly and effortlessly with BLUMOTION.





## Offices and hallways

Practical solutions promote efficiency in offices, and all kinds of items need to be stored and hung on hall stands. High quality fittings systems bring top quality motion and enhanced user convenience to daily living spaces.



You can quickly find accessories in the drawers and pull-outs of a hall stand.



## Shops

Shop fit-outs must meet special demands. The focus is on the beautiful and well-structured presentation of high quality merchandise. Blum's high quality fittings help you meet every wish.





LEGRABOX for storing and presenting merchandise.



# DYNAMIC SPACE

Blum's ideas for practical kitchens

**blum**



Ideas from Blum  
for practical kitchens



Blum has been investigating the needs of kitchen users for years. The insights gained are used to develop new products that make opening and closing furniture simple and convenient. After all, furniture should not only look good, it should be practical, too.



> [www.blum.com/ideas](http://www.blum.com/ideas)



## Features of a practical kitchen

### Workflow – Convenience

Putting away items, preparing food and cooking meals - many chores need doing on a daily basis. To minimise the number of steps you have to take, arrange kitchen cabinets according to typical workflows. This creates work areas or zones. Items are stored right where they're needed. And high quality cabinet equipment and inner dividing systems provide easy access.



> DYNAMIC SPACE  
video

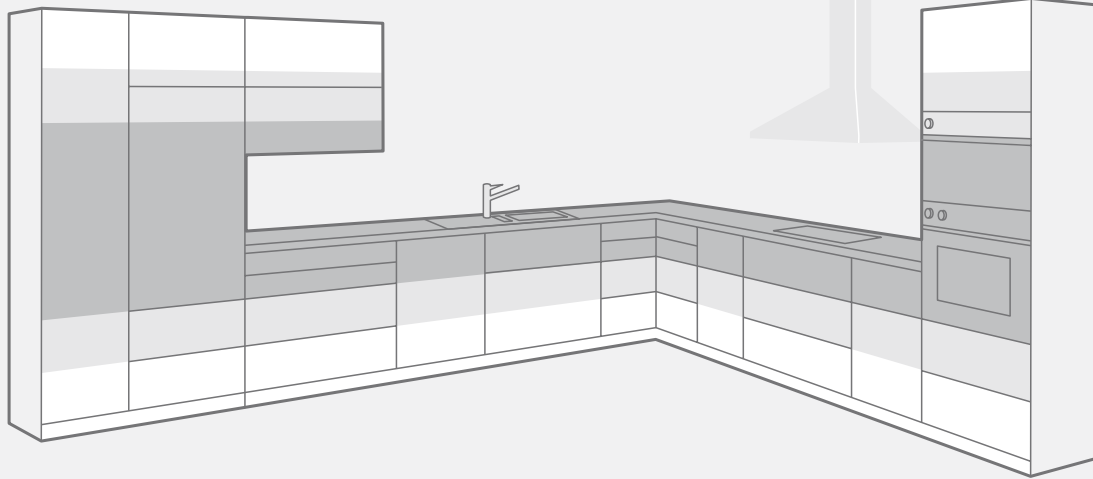

Frequently used items should be immediately to hand. That's why they should be kept in places that are within easy ergonomic reach. Items that are used less frequently should be stored at the top or bottom of a kitchen.

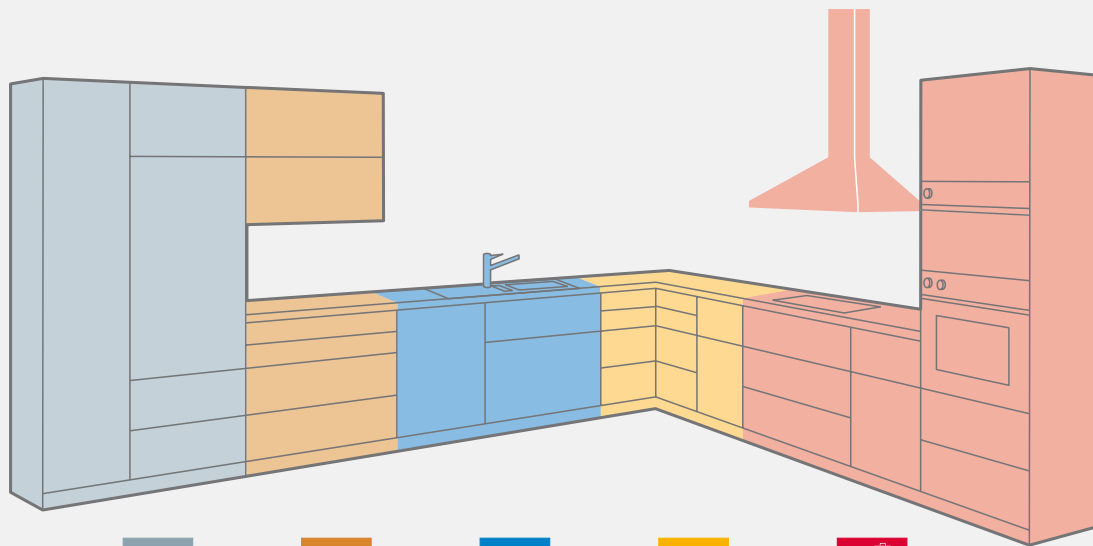

Dividing a kitchen into five zones shortens distances and makes workflows smoother.

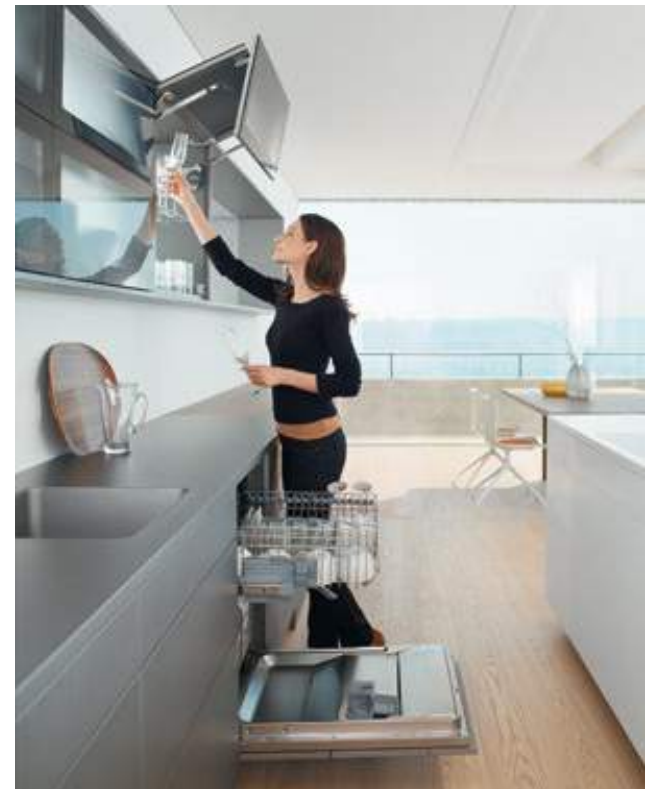

The fronts of lift systems lift up and out of the user's way providing easy access to contents.





## Features of a practical kitchen

### Space – Optimisation

It's important to have enough storage space so that everything is where it should be and immediately to hand. No matter how big the kitchen, Blum's solutions help you make optimal use of the space available and meet individual storage space needs.

How to create more storage space

Use higher side panels

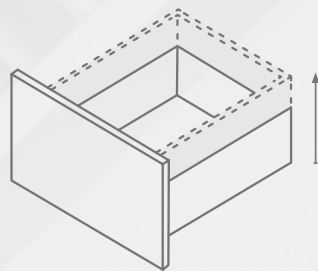

Use wider units

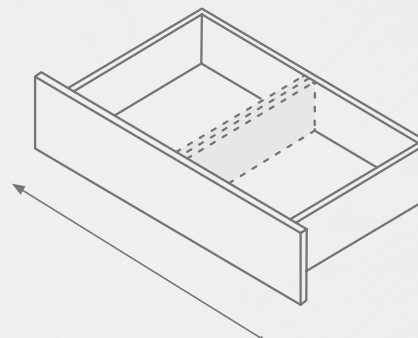

Use deeper units

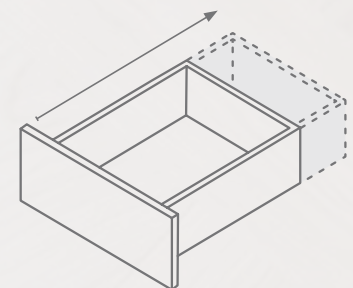



## Features of a practical kitchen

### Motion – Quality

Kitchen furniture sees intensive use over the years. That's why quality of motion and user convenience are so important. Blum's solutions bring top quality motion to kitchens. Furniture opens by itself with the SERVO-DRIVE electric motion support system, pull-outs have a feather-light glide and everything closes softly and effortlessly with BLUMOTION.



Quality of motion is  
quality of life

 **blum**



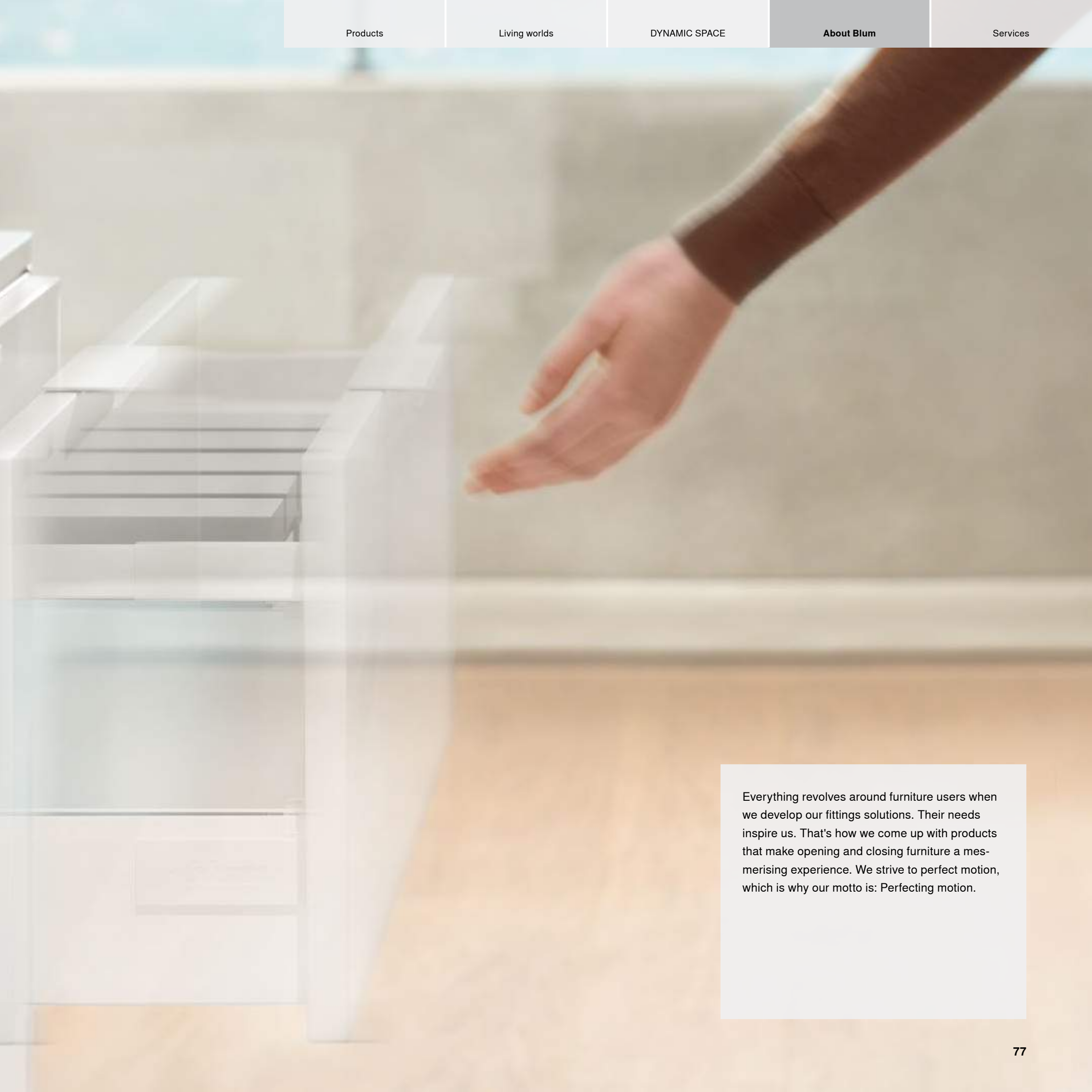

Everything revolves around furniture users when we develop our fittings solutions. Their needs inspire us. That's how we come up with products that make opening and closing furniture a mesmerising experience. We strive to perfect motion, which is why our motto is: Perfecting motion.



## Design

Blum's fittings systems don't just look good, they offer a multitude of design possibilities, too. Your concept might focus on horizontal composition, vertical harmony or the extensiveness of fronts. Everything is possible with Blum. For Blum supports functionality and creative design.

A man with glasses and a black turtleneck is looking at a modern, light-colored cabinet. A vertical wooden handle is attached to the cabinet. The background is a blurred office or studio setting.

**blum**<sup>®</sup>



With or without handles - great scope for design.



# Blum

Blum was founded by Julius Blum more than 60 years ago and is a family-owned company that operates on an international scale. Its strategic business segments include hinge, pull-out and lift systems. All product developments focus on perfecting motion.

[www.blum.com](http://www.blum.com)







### Blum in Austria and around the world

Blum has seven plants in Vorarlberg, Austria as well as further production sites in Poland, the USA and Brazil and 27 subsidiaries and/or representative offices. The company supplies more than 100 markets. The Blum Group employs 5,900 people in total, 4,500 of whom work in Vorarlberg.

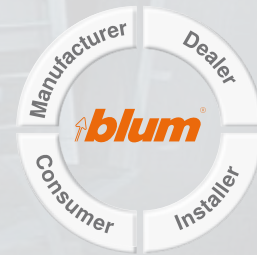

### Global customer benefits

"Everyone who uses Blum products should benefit from them - be its manufacturers, dealers, fitters or kitchens users." This is Blum's philosophy of global customer benefits.



### Innovations

To support customers with innovative fittings solutions and secure long-term success for the company, we need to consistently invest in research and development, in plants and facilities and in employee training. With more than 1,200 registered trademarks around the world, Blum is one of Austria's most innovative companies.



### Quality

Blum's concept of quality is comprehensive and does not only apply to its products. Services and cooperation with customers and partners must meet the same high quality standards.



### Environment

At Blum, we believe that responsible ecological behaviour has long-term economic benefits. The longevity of products is just one of many important aspects. Further important measures include the use of environmentally-friendly processes, the intelligent use of materials and prudent energy management.



### DYNAMIC SPACE

Good workflows, sufficient storage space and top quality motion are important features of a practical kitchen. Blum's ideas for practical kitchens are designed to bring function, convenience and ergonomics to furniture interiors.





# Services for designers and architects

 **blum**









It is important to us to assist you with everything related to fittings systems and that is why we offer a comprehensive range of services.

### **E-SERVICES**

#### **Everything on the net. Everything to hand.**

We offer a wide range of planning and designing services. We provide useful information and helpful details about our products - up-to-date and downloadable at any time.



> <http://e-services.blum.com>

### **Services for designers and architects**

We have put together comprehensive tender documentation and texts to make your job easier. You can order the tender folder from us or download the digital version of the tendering texts yourself.



> [www.blum.com/interiordesigners](http://www.blum.com/interiordesigners)



International presence. Our subsidiaries and representative offices are at your disposal in many countries all over the world.



Julius Blum GmbH  
Furniture Fittings Mfg.  
6973 Hoechst, Austria  
Tel.: +43 5578 705 0  
Fax: +43 5578 705 44  
Email: [info@blum.com](mailto:info@blum.com)  
[www.blum.com](http://www.blum.com)

